



SERIES
PLK22
Jet Glue Gun

KAS[®]



www.TOPGUARD.tech

PLK25 GLUE GUN

Fully electric glue gun

Series PLK25

The PLK25 glue gun is a real allrounder. Developed for the highest speeds, it ensures excellent dot application with fantastic tear off behavior. This flow optimized adhesive application gun achieves the best Kv¹ value which KAS ever tested. In this way, it more than meets the high demands of folding box production and opens up completely new perspectives in folding box gluing. Also the adaptability of this glue gun to different requirements is also astonishing. By using different actuator coils, the glue gun parameters such as force, speed and precision can be changed so that the valve is optimally adapted to the application. In addition to all these overwhelming features, the PLK25 glue gun is very robust and durable and even has an over-temperature protection that is missing from other valves but which is a guarantee of reliability and a long service life.



The PLK25 series glue application guns are the best choice when it comes to accurate and safe precision application at high speeds and difficult application conditions.

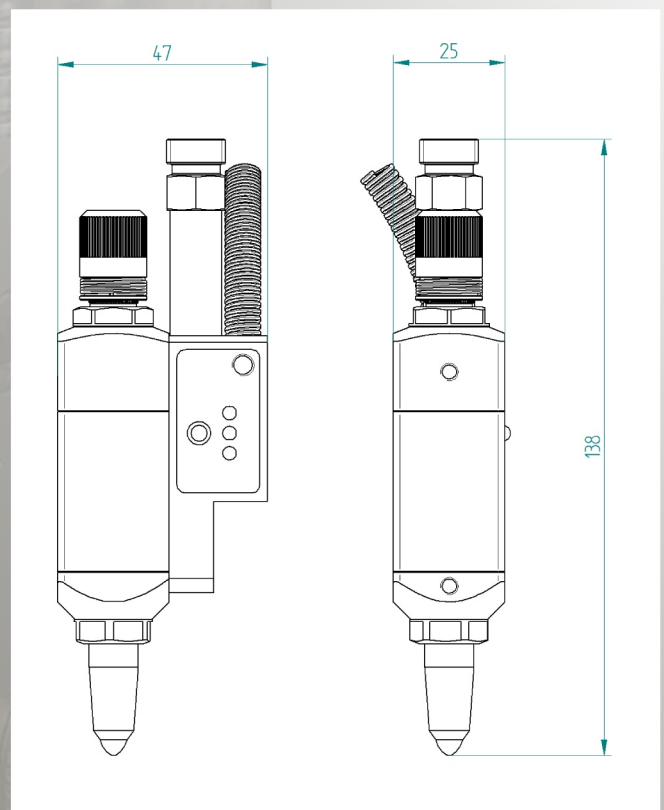

TECHNICAL DATA	PLK25	units
max. working pressure	50	bar
maximum glue viscosity	3000	mPaS
optimum glue viscosity	1000	mPaS
temperature range	15 - 60	°C
max. relative humidity	70	%
noise emission	< 70	dBa
switching frequency	800	Hz

Note 1:
The kv-value of a valve indicates the volume flow in m³ /h with a specific stroke (cv-value) and a pressure loss of 1.0 bar.

Technical changes and errors are subject to change

KAS[®]

KAS GmbH

An der Lehmkuhle 8
37359 KUELLSTEDT

Tel. +49 36075 589390 

Tel. +49 36075 589391 

Fax +49 36075 589392

email info@KAS-SYSTEMS.de

web www.KAS-SYSTEMS.de

PLK25 Glue Gun

Fully electric high-speed glue gun